

Instruction Manual

HI 9913 - HI 9923 HI 9935

Wall Mounted Dual Conductivity/TDS & pH Controllers

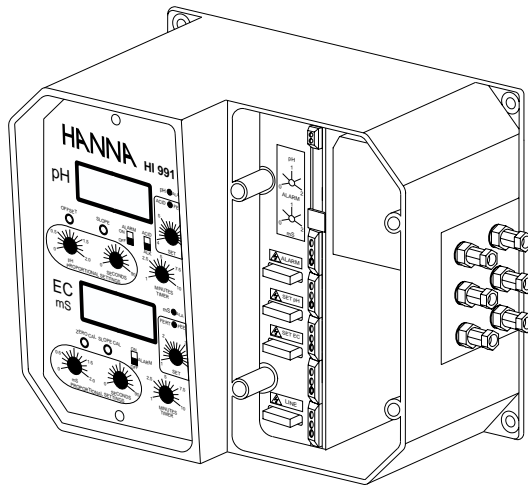

<http://www.hannainst.com>

These Instruments are in
Compliance with the CE Directives

Dear Customer,

Thank you for choosing a Hanna Product.

Please read this instruction manual carefully before using the instrument. This manual will provide you with the necessary information for a correct use of the instrument, as well as a more precise idea of its versatility. If you need more technical information, do not hesitate to e-mail us at tech@hannainst.com.

These instruments are in compliance with the **CE** directives EN 50081-1, 50082-1 and 61010-1.

TABLE OF CONTENTS

PRELIMINARY EXAMINATION	3
GENERAL DESCRIPTION	3
MECHANICAL LAYOUTS	4
FUNCTIONAL DIAGRAM HI 9913	6
FUNCTIONAL DIAGRAM HI 9923	9
FUNCTIONAL DIAGRAM HI 9935	12
CONNECTIONS & WIRING	14
NORMAL OPERATION & MEASUREMENT	19
pH CALIBRATION	20
CONDUCTIVITY/TDS CALIBRATION	21
ADJUSTMENT OF SETPOINT(S)	23
PROPORTIONAL CONTROL	24
CONDUCTIVITY DEAD BAND (HI 9923)	26
OVERDOSAGE TIMERS	26
pH VALUES AT VARIOUS TEMPERATURES	27
pH ELECTRODE CONDITIONING & MAINTENANCE	28
CONDUCTIVITY/TDS PROBE CLEANING & MAINTENANCE	29
SUGGESTED INSTALLATIONS FOR pH ELECTRODE	30
SUGGESTED INSTALLATIONS FOR EC/TDS PROBE	31
ACCESSORIES	33
WARRANTY	34
CE DECLARATION OF CONFORMITY	35

PRELIMINARY EXAMINATION

Remove the instrument from the packing material and examine it carefully to make sure that no damage has occurred during shipping. If there is any noticeable damage, notify your Dealer.

Note: Save all packing materials until you are sure that the instrument functions correctly. Any defective item must be returned in the original packaging together with the supplied accessories.

IMPORTANT:

1. Read the instructions before using the instrument.
2. The instrument should be connected to a mains socket.
3. Never install the controller outdoors, in a wet or humid area or under direct sun light. Nor install the controller where liquids may be sprayed or poured on it.
4. The instrument's main power line as well as the dosage and alarm terminals are protected by separate 2A fuses. Use only 2A fuses for replacement.

GENERAL DESCRIPTION

Hanna's wall-mounted conductivity/TDS and pH controllers are designed to meet a variety of process control requirements, especially those in horticultural, hydroponics and agricultural applications on the one hand and boilers and cooling towers on the other.

All controllers provide for two separate relays, one for pH and another for Conductivity/TDS. HI 9913 and HI 9935 also come with proportional control to save on use of chemicals and fertilizers.

All models operate with the optional Hanna 4-ring probes to provide a linear and repeatable measurement. The conductivity/TDS probes can be installed quickly and easily. Simply plug the DIN connector into the socket and tighten the retainer ring.

The EC/TDS probes incorporate a temperature sensor and the controllers will automatically compensate for the temperature effect. Accurate measurements are displayed on a large LCD.

Similarly, the pH electrode can be installed quickly and easily. Simply plug the universal BNC connector into the socket and twist it into a secured position. In order to avoid electrical noise and interference, the pH circuitry also provides for a ground probe (differential input).

The controllers come equipped with relays operating at a maximum of 2A (240V).

They incorporate a triple contact alarm system. When activated, the alarm contacts will open or close, triggering the mechanism of your choice, whether a buzzer, light or any other electrical device.

The controllers are housed in a rugged, modular, fiber-reinforced ABS housing.

All models can be wired to work with 110/115V or 220/240V at 50/60 Hz power supplies.

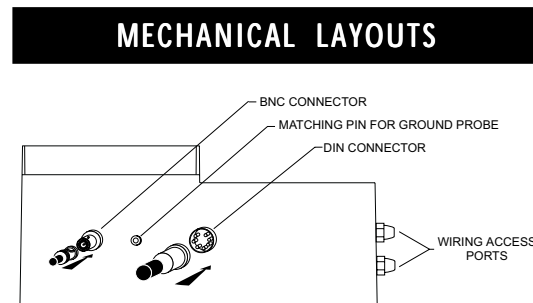

Fig. 1

Figure 1 illustrates the connector for pH electrode, matching pin connection, conductivity/TDS probe and the wiring access ports.

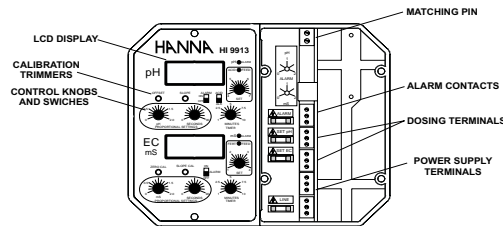

Fig. 2

Figure 2 illustrates the controls and terminals.

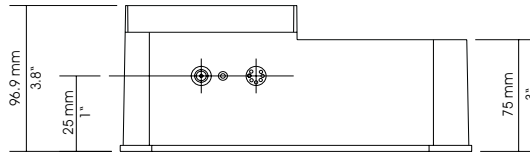

Fig. 3

Figure 3 is a dimensioned, bottom view of the wall mounted controller. The modular design isolates the control circuitry from the contacts making it possible to make the connections and then close the compartment. Adjustments can then be made only in the control area, without having to open the contacts compartment.

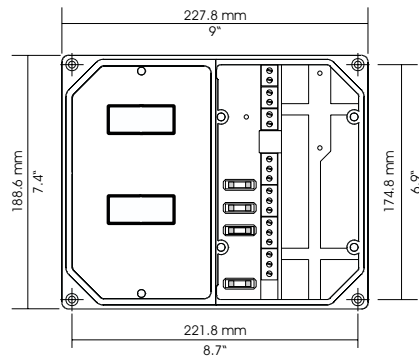
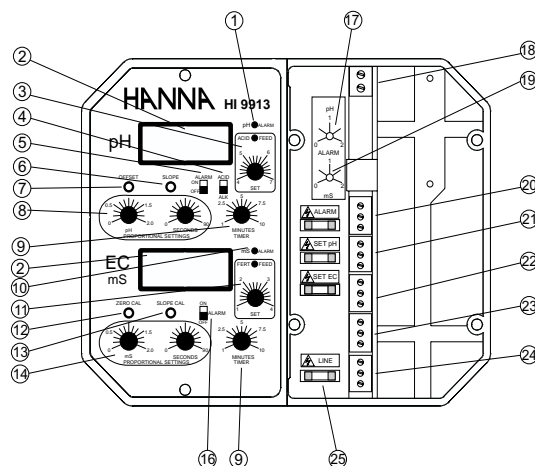

Fig. 4

Figure 4 is a dimensioned front view of the wall mounted controller. The molded, mounting holes in the corners provide for quick and secure installation. No additional hardware is needed for mounting. All electrical connections and controls are located on the front of the instrument so that adjustment can be made without having to remove the unit.

FUNCTIONAL DIAGRAM HI 9913

FRONT PANEL



Left panel

1. Alarm LED signal for pH
2. Liquid Crystal Display for pH and Conductivity (EC)
3. Acid feed LED and dial to adjust the pH setpoint
4. Selection switch for Acid or Alkaline dosage
5. Alarm disable switch for pH
6. Slope calibration trimmer for pH
7. Offset calibration trimmer for pH
8. Proportional pH band and time cycle settings
9. Two independent overdosage timers
10. Alarm LED signal for Conductivity (EC)
11. Fertilizer feed LED and dial to adjust the Conductivity setpoint
12. Zero calibration trimmer for Conductivity (EC)
13. Slope calibration trimmer for Conductivity (EC)
14. Proportional Conductivity band and time cycle settings
16. Alarm disable switch for Conductivity (EC)

Right panel

17. pH alarm setting from 0.0 to 2.0 pH
18. Short the terminals if a pH ground probe is not in use, or connect the ground probe wire to the Matching Pin terminal
19. Conductivity alarm setting from 0 to 2.0 mS/cm (EC)

20. Triple contact alarm in a Normally Closed (NC) or a Normally Open (NO) position.
21. Powered dosage terminals (Relay) for pH correction
22. Powered dosage terminals (Relay) for EC correction
23. 110/115V or 220/240V power configuration
24. Incoming power terminals
25. Fuses

BOTTOM VIEW

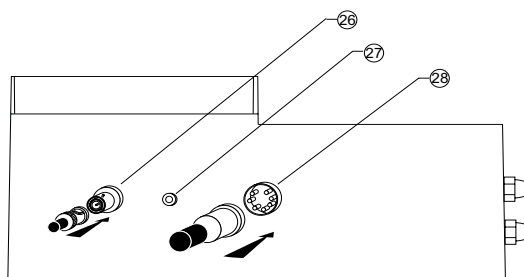

26. Female BNC connector for a combination pH electrode
27. 4-mm Banana socket for the pH ground probe
28. Female DIN connector for Conductivity probe



Unplug the instrument from the power supply before wiring or replacing the fuses.

Specifications	HI 9913
RANGE	0.00 to 14.00 pH and 0.00 to 10.00 mS/cm (EC)
RESOLUTION	0.01 pH and 0.01 mS/cm
ACCURACY (@20°C/68°F)	±0.02 pH and ±2% F. S.
TYPICAL EMC DEVIATION	±0.1 pH and ±2% F. S.
CALIBRATION	Through "OFFSET" and "SLOPE" trimmers for pH, and "ZERO CAL" and "SLOPE CAL" for Conductivity (EC)
SETPOINT RANGE	From 4.0 to 7.0 pH and 1.0 to 4.0 mS/cm (EC)
PROPORTIONAL CONTROL	Two independent controls: pH from 0.0 to 2.0 and Conductivity (EC) from 0.0 to 2.0 mS/cm with two separate time cycles from 0 to 90 seconds
ALARM CONTACT	Terminals can be configured as normally open or normally closed (isolated output Max. 2A, Max. 240V, resistive load, 1,000,000 strokes). The alarm is activated if pH falls below the setpoint by the user- selectable interval (0.0 to 2.0 pH), or conductivity exceeds the setpoint by more than the user-selectable interval (0 to 2.0 mS/cm) or due to overdosage
PROBE	Any combination pH electrode with a universal BNC connector and Hanna Conductivity 4-ring potentiometric probe with built-in temperature sensor and DIN connector (optional)
DOSING TERMINALS	Two sets of independent terminals (115 to 240V, Max.2A, 1,000,000 strokes) are activated whenever pH exceeds the pH setpoint and/or conductivity falls below the EC setpoint
POWER SUPPLY	220/240V or 110/115V at 50/60Hz
ENVIRONMENT	-10 to 50°C (14 to 122°F) max. 95% RH non-condensing
WEIGHT	1.6 Kg (3.5 lb.)
ENCLOSURE	181 x 221 x 142mm (7.1 x 8.7 x 5.6")
CASE MATERIAL	Fiber-reinforced, self-extinguishing ABS

FUNCTIONAL DIAGRAM HI 9923

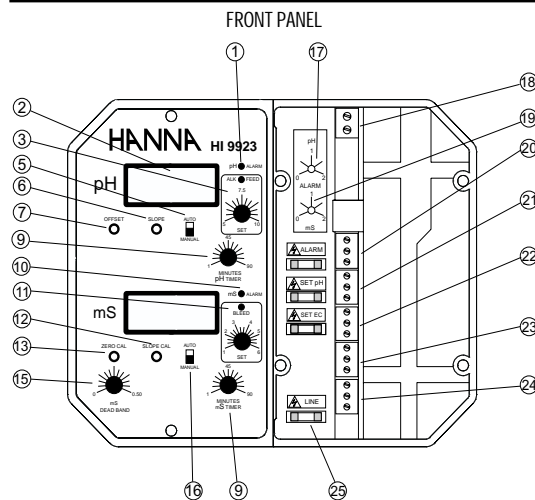

Left panel

1. Alarm LED signal for pH
2. Liquid Crystal Display for pH and Conductivity
3. Alkaline feed LED and dial to adjust the pH setpoint
5. Alarm disable switch for pH
6. Slope calibration trimmer for pH
7. Offset calibration trimmer for pH
9. Two independent overdosage timers
10. Alarm LED signal for Conductivity
11. Bleed LED and dial to adjust the Conductivity setpoint
12. Zero calibration trimmer for Conductivity
13. Slope calibration trimmer for Conductivity
15. Conductivity Dead Band setting
16. Alarm disable switch for Conductivity

Right panel

17. pH alarm setting from 0.0 to 2.0 pH
18. Short the terminals if a pH ground probe is not in use, or connect the ground probe wire to the Matching Pin terminal
19. Conductivity alarm setting from 0 to 2.0 mS/cm
20. Triple contact alarm in a Normally Closed (NC) or a Normally Open (NO) position.
21. Powered dosage terminals (Relay) for pH correction
22. Powered dosage terminals (Relay) for Conductivity correction

23. 110/115V or 220/240V power configuration
24. Incoming power terminals
25. Fuses

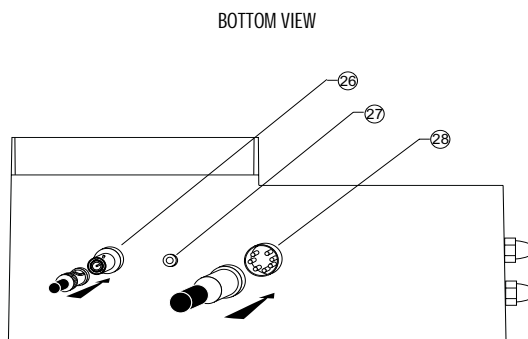

26. Female BNC connector for a combination pH electrode
27. 4-mm Banana socket for the pH ground probe
28. Female DIN connector for conductivity probe



Unplug the instrument from the power supply before wiring or replacing the fuses.

Specifications	HI 9923
RANGE	0.00 to 14.00 pH and 0.00 to 10.00 mS/cm (mmho/cm)
RESOLUTION	0.01 pH and 0.01 mS/cm (mmho/cm)
ACCURACY (@20°C/68°F)	± 0.02 pH and ± 2% F. S.
TYPICAL EMC DEVIATION	± 0.1 pH and ± 2% F. S.
CALIBRATION	Through "OFFSET" and "SLOPE" trimmers for pH, and "ZERO CAL" and "SLOPE CAL" for Conductivity
SETPOINT RANGE	From 5.0 to 10.0 pH & 1.00 to 6.00 mS/cm (mmho/cm)
DEAD BAND	From 0.0 to 0.5 mS/cm (mmho/cm)
ALARM CONTACT	Terminals can be configured as normally open or normally closed (isolated output Max. 2A, Max. 240V, resistive load, 1,000,000 strokes). The alarm is activated if pH exceeds the setpoint by the user-selectable interval (0 to 2 pH), or Conductivity falls below the setpoint by more than the user-selectable interval (0 to 2.0 mS/cm) or due to overdosage
PROBE	Any combination pH electrode with a universal BNC connector and Hanna Conductivity 4-ring potentiometric probe with built-in temperature sensor and DIN connector (optional)
DOSING TERMINALS	Two sets of independent terminals (115 to 240V, Max. 2A, 1,000,000 strokes) are activated whenever pH falls below the pH setpoint or the conductivity exceeds the "BLEED" setpoint
POWER SUPPLY	220/240V or 110/115V at 50/60Hz
ENVIRONMENT	-10 to 50°C (14 to 122°F) max. 95% RH non-condensing
WEIGHT	1.6 Kg (3.5 lb.)
ENCLOSURE	181 x 221 x 142mm (7.1 x 8.7 x 5.6")
CASE MATERIAL	Fiber-reinforced, self-extinguishing ABS

FUNCTIONAL DIAGRAM HI 9935

FRONT PANEL

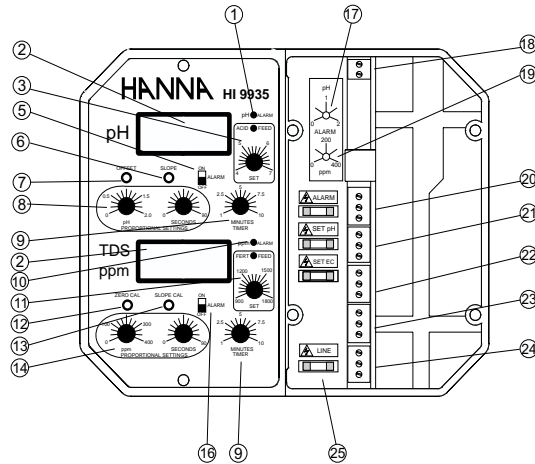

Left panel

1. Alarm LED signal for pH
2. Liquid Crystal Display for pH and TDS (ppm or mg/L)
3. Acid feed LED and dial to adjust the pH setpoint
5. Alarm disable switch for pH
6. Slope calibration trimmer for pH
7. Offset calibration trimmer for pH
8. Proportional pH band and time cycle settings
9. Two independent overdosage timers
10. Alarm LED signal for TDS
11. Fertilizer feed LED and dial to adjust the TDS setpoint
12. Zero calibration trimmer for TDS
13. Slope calibration trimmer for TDS
14. Proportional TDS band and time cycle settings
16. Alarm disable switch for TDS

Right panel

17. pH alarm setting from 0.0 to 2.0 pH
18. Short the terminals if a pH ground probe is not in use, or connect the ground probe wire to the Matching Pin terminal
19. TDS alarm setting from 0 to 400 ppm (mg/L)
20. Triple contact alarm in a Normally Closed (NC) or a Normally Open (NO) position.

21. Powered dosage terminals (Relay) for pH correction
22. Powered dosage terminals (Relay) for TDS correction
23. 110/115V or 220/240V power configuration
24. Incoming power terminals
25. Fuses

BOTTOM VIEW

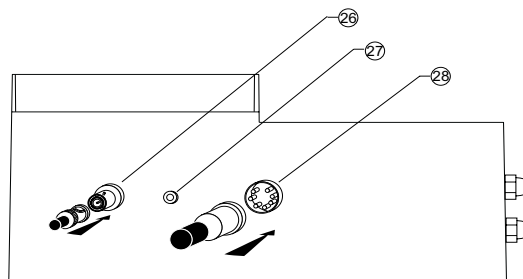

26. Female BNC connector for a combination pH electrode
27. 4-mm Banana socket for the pH ground probe
28. Female DIN connector for TDS probe



Unplug the instrument from the power supply before wiring or replacing the fuses.

Specifications	HI 9935
RANGE	0.00 to 14.00 pH and 0.00 to 1999 ppm (mg/L)
RESOLUTION	0.01 pH and 1 ppm (mg/L)
ACCURACY (@20°C/68°F)	±0.02 pH and ±2% F. S.
TYPICAL EMC DEVIATION	±0.1 pH and ±2% F. S.
CALIBRATION	Through "OFFSET" and "SLOPE" trimmers for pH, and "ZERO CAL" and "SLOPE CAL" for TDS
SETPOINT RANGE	From 4.0 to 7.0 pH and 900 to 1800 ppm (mg/L)
PROPORTIONAL CONTROL	Two independent controls: pH from 0.0 to 2.0 and TDS from 0.0 to 400 ppm (mg/L) with two separate time cycles from 0 to 90 seconds
ALARM CONTACT	Terminals can be configured as normally open or normally closed (isolated output Max. 2A, Max. 240V, resistive load, 1,000,000 strokes). The alarm is activated if pH falls below the setpoint by the user- selectable interval (0 to 2 pH), or TDS exceeds the setpoint by more than the user-selectable interval (0 to 400 ppm) or due to overdosage
TDS RATIO	0.65 ppm (mg/L) = 1 µS/cm
PROBE	Any combination pH electrode with a universal BNC connector and Hanna TDS 4-ring potentiometric probe with built-in temperature sensor and DIN connector (optional)
DOSING TERMINALS	Two sets of independent terminals (115 to 240V, Max. 2A, 1,000,000 strokes) are activated whenever pH exceeds the pH setpoint and for the TDS falls below the TDS setpoint
POWER SUPPLY	220/240V or 110/115V at 50/60Hz
ENVIRONMENT	-10 to 50°C (14 to 122°F) max. 95% RH non-condensing
WEIGHT	1.6 Kg (3.5 lb.)
ENCLOSURE	181 x 221 x 142mm (7.1 x 8.7 x 5.6")
CASE MATERIAL	Fiber-reinforced, self-extinguishing ABS

CONNECTIONS & WIRING

GENERAL POINTS

- The **relay terminals** of the controller are **powered**. This means that you can simply hook up your pump or electrovalve directly to the controller and do not need additional power supply.

- Unscrew the 4 screws on the right hand panel and remove the cover and the gasket. Thread the wires through the access ports on the right hand side of the controllers.
- **Before connecting the controller to the mains, wire the controller completely** and make all the connections for pumps, valves, alarm, probe, set the alarm threshold and adjust the settings. Upon completion **replace the cover**. *Only then* connect the controller to the power supply.

pH ELECTRODE & GROUND PROBE CONNECTIONS

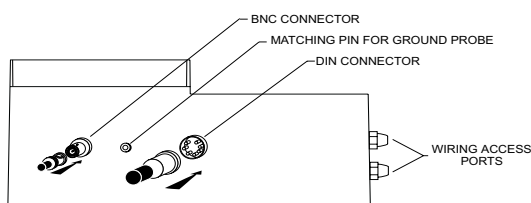

- Simply attach any combination pH electrode with a male BNC connector (such as HI 1002/3) to the female BNC socket located on the bottom of the casing and twist it into a secure position.
- All controllers provide for a Ground Probe (differential input) to reduce electrical noise and interference. The controller is shipped with the Matching Pin and Reference terminals shorted (see 18 - Functional Diagram). If you are not using a matching pin (ground probe), **leave the terminals shorted** and skip the next two paragraphs.
- It is recommended that only electrodes that incorporate a matching pin (such as HI 1003/3) are utilized. In this case simply **attach the 4-mm banana connector of the matching pin to the socket** located next to the BNC connector on the outer casing (see 27 and 18 - Functional Diagram) and **remove the jumpers** shorting the matching pin terminals.
- When using a separate probe for grounding purposes, wire it to the Matching Pin terminals on the right hand panel and remove the jumpers (see 18 - Functional Diagram).

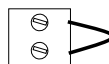

NOTE:

NEVER leave the jumper in when using an electrode with a matching pin. This can shorten the life of the electrode (reference) drastically.

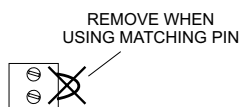

CONDUCTIVITY/TDS PROBE CONNECTION

- Attach the conductivity/TDS probe (HI 3002, HI 3001D or HI 7638) to the DIN socket located on the bottom of the casing. Align the guide on the connector with the socket, push the connector in and tighten the retainer ring. (HI 3002 is more suitable for direct immersion in the tank, vat or pipes. HI 3001D can be mounted directly into a pipe and HI 7638 is recommended for high temperature and pressure applications).
- The probes incorporate a temperature sensor and the controller's circuitry automatically compensates for the temperature effect.

RELAY CONNECTIONS

- The controllers provide for two separate relays, one for pH and another for Conductivity (or TDS).
- Wire the external devices (pumps or electrovalves) directly to the relay terminal strips of the controller (see 21 and 22 - Functional Diagram). The **terminals are powered** and hence you **do not need an external power supply** for the pumps or electrovalves.
- The relay for the pH is activated when pH exceeds the setpoint (HI 9913 and HI 9935) or falls below the setpoint (HI 9923). The relay for conductivity/TDS instead acts in the opposite direction, i.e. it is activated when the conductivity (or TDS) falls below the setpoint (HI 9913 and HI 9935) or exceeds the setpoint (HI 9923).

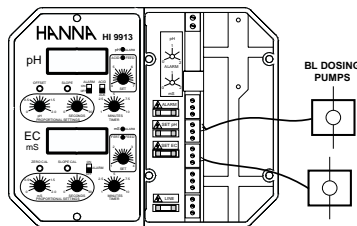

ALARM CONNECTIONS

- The operator can select an alarm threshold of 0.0 to 2.0 pH by turning the alarm knob (see 17 - Functional Diagram). If the pH measurements fall below the setpoint (HI 9913 and HI 9935) or are above the setpoint (HI 9923) by a margin greater than the user-selectable alarm threshold, the alarm terminal is activated.

- The operator can similarly select an alarm threshold of 0.0 to 2.0 mS/cm (HI 9913 and HI 9923) or 0 to 400 ppm (HI 9935) by turning the alarm knob (see 19 - Functional Diagram). If the conductivity/TDS measurements exceed the setpoint (HI 9913 and HI 9935) or the conductivity falls below the setpoint (HI 9923) by a margin greater than the user-selectable alarm threshold, the alarm terminal is activated.
- The alarm can be selected as normally closed ("NC") by connecting the external device to the C and NC terminals or normally open ("NO") by connecting the external device to the C and NO terminals.
- When activated, the alarm contacts will open or close, triggering the mechanism of your choice. When the **alarm is activated all other terminals** (such as dosing relay etc.) **are deactivated**. The alarm LED lights also come on.

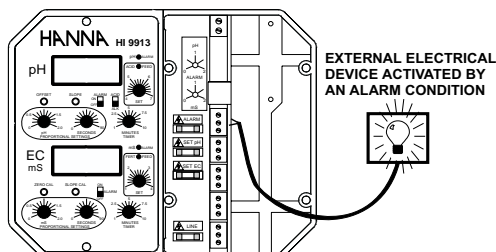
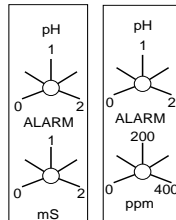

- The alarm AUTO/MANUAL switches are only to **disable the alarm terminal** (e.g. the buzzer will not sound). However, all other functions such as disactivation of the dosing relay remains unvaried, i.e. the pump or electrovalve will cease to operate until the alarm condition is alleviated.
- If the pH AUTO/MANUAL switch is in the MANUAL position, the buzzer/light will not come on if the pH value is out. The alarm will be sounded for Conductivity/TDS anomalies, unless likewise, the Conductivity/TDS switch is also in the manual position.
- The controller provides for **automatic fail-safe** security by activating the alarm if there is a power failure, regardless of whether the NC or NO configurations were chosen.



- The alarm is also activated if one or both of the independent maximum dosage times are exceeded. The maximum time that the relay contacts remain active continuously (max. dosage time) can be set from 1 to 10 minutes for HI 9913 and HI 9935 and 1 to 90 minutes for HI 9923.
- Once in an alarm condition, the contact remains activated until the switch is put in the manual position or the measurements return to normal values.

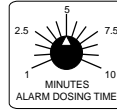

TEMPERATURE COMPENSATION

Temperature affects conductivity and TDS measurements considerably (approx. 2% per degree Celsius). You however do not need to worry about having to compensate for this or go through complicated calculations since all three probes recommended in this manual (HI 7638, HI 3002 and HI 3001D) compensate for the temperature effect automatically.

MAIN POWER SUPPLY CONNECTION

- **Before connecting the unit to the mains**, make sure that the **controller is completely wired** and that all connections for pump, alarm, probe, etc. have been made.
- For 220-240V, short the L1 and N1 terminals. Then wire the external power supply to the three terminals as shown.
- For 110-115V, short the L and L1 terminals *and* the N1 and Neutral. Then wire the external power supply to the three terminals as shown.
- Replace the cover with the gasket and screw it tight with the 4 screws provided. *Only then* connect the controller to the mains.

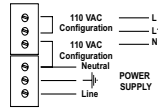
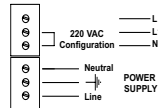

NORMAL OPERATION & MEASUREMENT

Make sure that the controller has been properly calibrated before commencing and that the pH and conductivity/TDS setpoints have been adjusted (see following pages).

The pH electrode, conductivity/TDS probe and any ground probe must be properly connected and wired to the controller (see preceding pages).

The conductivity/TDS probe's protective sleeve must not be removed and the holes on the sleeve should be near the top (the cable end). The probe must be immersed in the solution above the air-vent holes on the external sleeve. The probe must be installed in such a way as to minimize presence of air bubbles (see probe installation tips at the end of the manual).

Remove the protective cap if it is still on the tip of the pH electrode and ensure that the electrode is immersed in the solution (at least 4cm/1.5"). The electrode should be installed in such a way that it permanently lies in the solution whether in a well, tank or on the discharge pipe.

The controller provides for visual dosing status through two LED's (see 3 and 11 - Functional Diagram). The LED's light up when the controller is in the pH and/or conductivity/TDS dosage mode and the relays are activated.

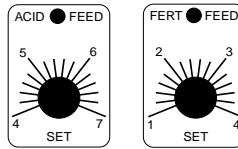

The actual pH and conductivity or TDS values are displayed on the two LCD's in pH and mS/cm or ppm, respectively.

pH 5.80

EC
mS 1.60

pH CALIBRATION

Make sure that the pH electrode and any ground probe have been properly connected and wired to the controller (see preceding pages) and that the meter is plugged to the mains.

Calibration should be performed at a temperature similar to that of the liquid to be monitored.

Use a Checktemp (or an accurate thermometer) as reference.

Remove the electrode cap if it is still on the electrode.

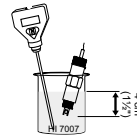

During calibration, move the electrode and the separate ground probe (if in use) together from one buffer to the next.

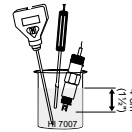

If no separate ground probe is being used, make sure that the Reference and the Matching Pin terminals are shorted (see 18 - Functional Diagram).

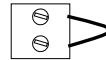

If the electrode (such as HI 1003/3) incorporates a ground probe (matching pin) then remove the jumper.

OFFSET ADJUSTMENT:

- Rinse the tip of the electrode with pH 7.01 solution (HI 7007), then dip the bottom 4 cm (1.5") of the electrode (and ground probe) in the pH 7.01 buffer.
- Place the Checktemp thermometer in the buffer solution.
- Wait for the measurement to stabilize and then adjust the "OFFSET" trimmer (see 7 - Functional Diagram) to display 7.01 on the LCD if the temperature of the buffer solution is at 25°C (77°F).

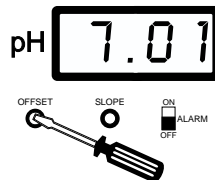
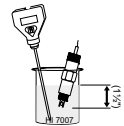

- If the temperature of the buffer solution is not 25°C (77°F), refer to the chart at the end of the manual for the appropriate buffer value at a given temperature and adjust the trimmer accordingly.

SLOPE ADJUSTMENT:

- Rinse the electrode (and ground probe) thoroughly with water and immerse the bottom 4 cm (1.5") in a pH 10.01 (HI 7010) or a pH 4.01 (HI 7004) buffer solution.

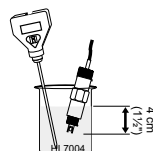

- Stir the electrode and wait for the display to stabilize before adjusting the "SLOPE" trimmer (see 6 - Functional Diagram) to display pH 4.01 (or 10.01) on the LCD if the temperature of the buffer solution is at 25°C (77°F). Otherwise, refer to the chart at the end of the manual for the appropriate buffer value and adjust the trimmer accordingly.

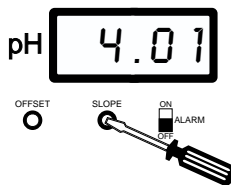

The pH calibration is now complete.

CONDUCTIVITY/TDS CALIBRATION

Make sure that the probe has been properly connected and wired to the controller (see preceding pages) and that the meter is plugged to the mains.

Calibration should be ideally performed at a temperature similar to that of the liquid to be monitored.



ZERO ADJUSTMENT:

- Leave the probe in the air and make sure that it is dry.
- The LCD should show 0. If necessary adjust the "ZERO CAL" trimmer to display zero (see 12 - Functional Diagram)

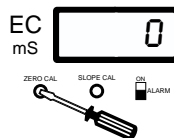

SLOPE ADJUSTMENT:

- Pour sufficient amount of a known conductivity or TDS solution in a beaker. The solution should ideally be close to the sample stream to be monitored. For example, when using the HI 9913, choose HI 7031L with a 1.41 mS/cm at 25 °C if the measure-

ments are in the 1.2 to 2.5 EC range. Similarly, utilize HI 7039L with a value of 5.00 mS/cm at 25 °C if controlling your process with HI 9923 and HI 70442L with a value of 1500 ppm (mg/L) value if working with HI 9935.

- Immerse the probe in the beaker ensuring that the holes on the sleeve of the probe are completely covered.

- Stir the probe and tap it gently on the bottom of the beaker to ensure that any air bubbles trapped inside the sleeve escape. Best results are obtained when the probe is not too close to the walls of the beaker nor lying on the bottom.

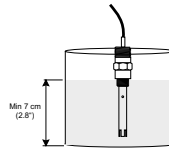

- Wait for the reading to stabilize. Adjust the "CAL SLOPE" trimmer to display the same value as the calibrations solution at 25 °C. For example, with HI 7031L, you should adjust the display to 1.41 mS/cm and with HI 70442 to 1500 ppm.

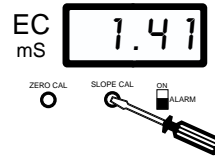

- Once the controller is calibrated to a solution by referring to its value at 25 °C, all subsequent measurements are temperature compensated to 25 °C. You can also obtain temperature compensation to a different temperature reference point by calibrating the meter to that value. For example, the conductivity and TDS values of HI 7031L and HI 70442L at 20 °C are 1.28 mS/cm and 1358 ppm, respectively. By adjusting the display to these values, all subsequent measurements are compensated to a base temperature of 20 °C.

Conductivity/TDS calibration is now complete.

ADJUSTEMENT OF SETPOINTS

Make sure that the pH electrode, conductivity/TDS probe and any ground probe have been properly installed and calibrated (see the preceding pages).

FOR pH

Simply turn the pH ACID FEED or ALK FEED dial (see 3 - Functional Diagram). The desired value can be chosen between 4 and 7 pH for HI 9913 and HI 9935, and 5 and 10 pH for HI 9923.

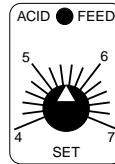

DOSING DIRECTION

The dosing terminals of HI 9935 are activated when the pH value exceeds the setpoint. HI 9935 will then dose acidic solutions to reduce the pH until the user-selected setpoint is reached.

The dosing terminals of HI 9923 instead are activated when the pH value falls below the setpoint. HI 9923 will then dose alkaline solutions to increase the pH until the user-selected setpoint is reached.

FOR EC/TDS

HI 9913 provides for an "ALK/ACID" switch (see 4 - Functional Diagram) so that the operator may select the direction. If the switch is left on "ACID", the terminals are activated when the pH value exceeds the setpoint. HI 9913 will then dose acidic solutions to reduce the pH until the user-selected setpoint is reached. Inversely, by leaving the switch on "ALK", the terminals are activated when the pH value falls below the setpoint. HI 9913 will then dose oxidants to increase the pH until the setpoint is reached.

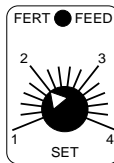

PROPORTIONAL CONTROL (HI 9913 & HI 9935)

In order to optimize the controlling process and reduce the amount of chemicals and fertilizers used, it is recommended to use a proportional dosage appropriate for the system.

HI 9913 and HI 9935 allow for a proportional band (delta) of 0 to 2.0 pH. They also allow for a proportional band of 0 to 2.0 mS/cm and 0 to 400 ppm for conductivity (EC) and TDS, respectively. Each controller also provides for two independent time cycles from 0 to 90 seconds. The proportional dosage is obtained by personalizing a current pulse

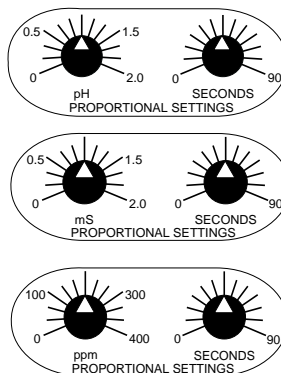

whose height equals the pH or EC/TDS proportional delta and the length corresponds to the selected time cycle.

The controller will enter **the proportional dosage** at the setpoint plus or minus the preselected delta. It will then keep the dosing relay activated for a period proportional to the difference between the actual measurement less the setpoint over the cycle.

NOTE:

- If the setting is left at 0 pH, the controller will operate as an ON/OFF control with no proportional dosage. In this case the controller will operate with a 0.1 pH hysteresis.
- Similarly, if the setting is left at 0 mS/cm or 0 ppm, the controller will operate as an ON/OFF control with no proportional dosage. The hysteresis of such an ON/OFF control will be 0.1 mS/cm or 15 ppm, respectively.
- **Do not set the time cycle to 0.** This causes the relay to chatter and can be detrimental to your controlling system and pump.
- Remember to select the "ALK" (alkaline) or "ACID" dosing direction (see 4 - Functional Diagram) before setting the pH proportional control. If you are to reduce the pH, choose "ACID" and inversely, switch to "ALK" to increase the pH level (HI 9913 only).

e.g. EC proportional control for HI 9913

Setpoint = 2.20 mS/cm (EC)

Measured value = 1.45 mS/cm

Delta = 2.20 - 1.45 = 0.75 mS/cm

Proportional settings = EC set to 1 and time cycle to 60 seconds

The controller will be dosing fertilizers to increase the EC to the desired limit. Since it is 0.75/1 = 75% away from

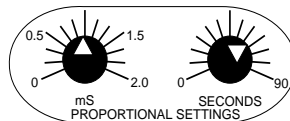

the ideal setting, it will keep the dosing really activated for 75% of the time over the predetermined 60 seconds. The terminals are hence theoretically activated for 45 seconds and off for 15 seconds.

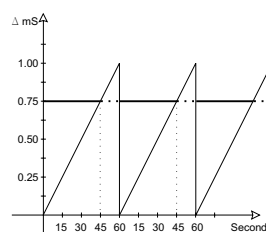

In order to avoid over dosage of highly concentrated chemicals or fertilizers, the controller provides even a more accurate control.

As the graphs show, it does that by stopping the dosage as soon as the current pulse curve intersects the dosage curve. This means shortening the dosage period if the chemicals have reacted quickly

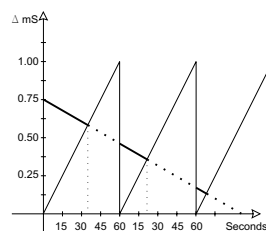

or lengthening it if the measured conductivity continues to drift from the ideal setpoint as can be seen from the graphs.

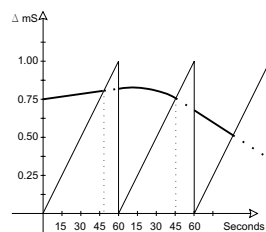

e.g. HI 9935 proportional control

Setpoint = 1600 ppm (TDS)

Measured value = 1550 ppm

Delta = 1600 - 1550 = 50 ppm

Proportional settings = ppm set to 200 and time cycle to 60 seconds

The controller will be dosing fertilizers to reach the desired value.

Since it is $50/200 = 25\%$ away from the ideal setting, it will keep the dosing really activated for 25% of the time over the predetermined 60 seconds. The terminals are hence activated for

15 seconds and off for 45 seconds until the next cycle.

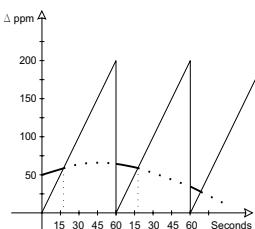

CONDUCTIVITY DEAD BAND (HI 9923)

HI 9923 provides for a user-selectable DEAD BAND (see 15 - Functional Diagram) which is deducted from the setpoint to decide the intervention point when bleeding the system. The DEAD BAND can be adjusted from 0 to 0.50 mS.

For example if 0.25 is dialed on the DEAD BAND, with the setpoint adjusted to 4 mS/cm (see 11 - Functional Diagram), the Conductivity relay will bleed the system until the reading reaches 3.75. It will then restart the bleed to correct the conductivity at 4.25.

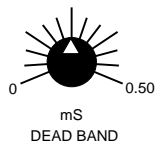

HI 9923 also provides for an ON/OFF pH control with a 0.1 pH hysteresis.

OVERDOSAGE TIMER

The controllers provide for an overdosage alarm system. The operator can set the maximum amount of time that the dosage terminals should continuously remain activated.

With HI 9913 and HI 9935, the cycles are selectable from 1 to 10 minutes for both pH and EC/TDS. For HI 9923 instead, the timers can be set from 1 to 90 minutes to allow for proper blow down of the boiler or cooling tower.

Should this period elapse, the alarm terminals are activated (and dosage terminals are deactivated). This is to ensure that fertilizers or chemicals have not run out or pumps or electrovalves have not ceased to function properly.

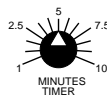

pH VALUES AT VARIOUS TEMPERATURES

Please refer to the following chart for a more accurate pH calibration:

TEMP		pHVALUES				
°C	°F	4.01	6.86	7.01	9.18	10.01
0	32	4.01	6.98	7.13	9.46	10.32
5	41	4.00	6.95	7.10	9.39	10.24
10	50	4.00	6.92	7.07	9.33	10.18
15	59	4.00	6.90	7.04	9.27	10.12
20	68	4.00	6.88	7.03	9.22	10.06
25	77	4.01	6.86	7.01	9.18	10.01
30	86	4.02	6.85	7.00	9.14	9.96
35	95	4.03	6.84	6.99	9.10	9.92
40	104	4.04	6.84	6.98	9.07	9.88
45	113	4.05	6.83	6.98	9.04	9.85
50	122	4.06	6.83	6.98	9.01	9.82
55	131	4.07	6.84	6.98	8.99	9.79
60	140	4.09	6.84	6.98	8.97	9.77
65	149	4.11	6.85	6.99	8.95	9.76
70	158	4.12	6.85	6.99	8.93	9.75

For instance, if the buffer temperature is 25°C (77°F), calibrate the meter to read 4.01, 7.01 or 10.01 on the display.

If the buffer temperature is 20°C, calibrate it to 4.00, 7.03 or 10.06.

If the buffer temperature is 50°C, calibrate it to 4.06, 6.98 or 9.82.

pH ELECTRODE CONDITIONING & MAINTENANCE

PREPARATION

Remove the protective cap.

DO NOT BE ALARMED IF ANY SALT DEPOSITS ARE PRESENT.

This is normal with electrodes and they will disappear when rinsed with water.

During transport tiny bubbles of air may have formed inside the glass bulb (membrane). shake down the electrode as you would do with a glass thermometer to remove these bubbles.

If the bulb and/or junction are dry, soak the electrode in a HI 70300 Storage Solution overnight.

STORAGE

To minimize clogging and assure a quick response time, the glass bulb and the junction should be kept moist and not allowed to dry out. This can be achieved by installing the electrode in such a way that it is constantly in a well filled with the sample (stream or tank).

When not in use, pour a few drops of HI 70300 Storage Solution or, in its absence, HI 7007 pH 7.01 Buffer Solution in the protective cap and replace it on the electrode.

Note: NEVER STORE THE ELECTRODE IN DISTILLED OR DEIONIZED WATER.

PERIODIC MAINTENANCE

Inspect the electrode and the cable. The cable used for the connection to the controller must be intact and there must be no points of broken insulation on the cable or cracks on the electrode stem or bulb.

The connector must be perfectly clean and dry. If any scratches or cracks are present, replace the electrode. Rinse off any salt deposits with water.

CLEANING PROCEDURE

Soak in Hanna HI 7061 General Cleaning Solution for ½ hour.

For more specific cleaning procedures, refer to the electrode's instruction manual.

IMPORTANT: After performing any of the cleaning procedure rinse the electrode thoroughly with distilled water and recalibrate the controller.

TROUBLESHOOTING

Evaluate your electrode performance based on the following.

- Noise (Readings fluctuate up and down) could be due to clogged/dirty junction: Refer to the Cleaning Procedure above.
- Dry Membrane/Junction: Soak in Storage Solution HI 70300 overnight. Check to make sure the installation is such as to create a well for the electrode bulb to constantly remain moist.
- Low Slope: Refer to the cleaning procedure above.
- No Slope: - Check the electrode for cracks in glass stem or bulb (replace the electrode if cracks are found).
- Make sure cable and connections are not damaged nor lying in a pool of water or solution.
- Slow Response/Excessive Drift: Soak the tip in Hanna Solution HI 7061 for 30 minutes, rinse thoroughly with distilled water and recalibrate the meter.

Note: With industrial applications, it is always recommended to keep at least one spare electrode handy. When anomalies are not resolved with a simple maintenance, change the electrode (and recalibrate the controller) to see if the problem is alleviated.

CONDUCTIVITY/TDS PROBE CLEANING & MAINTENANCE

PREPARATION

Make sure that the protective sleeve is on the probe shaft and that the air-vent holes are on the top (nearer to the cable).

STORAGE

The conductivity/TDS probes should be stored dry. If the probes are not to be used for a while, clean and dry them thoroughly (see below) before storing them in a dry store room.

PERIODIC MAINTENANCE

Inspect the probe and the cable. The cable used for the connection to the controller must be intact and there must be no points of broken insulation on the cable or cracks on the probe sleeve. If any cracks are present, replace the probe and cable.

Connector must be clean and dry.

CLEANING PROCEDURE

Remove the sleeve and soak the probe in a Hanna HI 7061 General Cleaning Solution for 1 hour.

If the probe has been left in highly concentrated fertilizer solution and does not seem to become clean, repeat the cleaning procedure.

The rings can also be cleaned with a cloth. Make sure that the cloth is made of a soft and non-abrasive material and does not scratch the rings.

IMPORTANT: After performing the cleaning procedure rinse the probe thoroughly with distilled or tap water. Dry the probe, replace the sleeve ensuring that the air-vents are nearer to the cable end and recalibrate the controller.

TROUBLESHOOTING

If the controller does not respond properly or constantly reads zero or a value close to it, or is in over range, check the probe and cable for cracks. The cable may be shorted or the probe broken, in which case they need to be replaced. If the response seems sluggish, follow the cleaning procedure above.

If there are anomalies such as numbers fluctuating, ensure that the probe has been properly mounted and that it constantly lies in a well filled with the solution. Air bubbles also disturb the measurements (especially with HI 3001D) and the probe should be installed in such a way as to minimize their presence (see Suggested Installations).

Note: With industrial applications, it is always recommended to keep a spare probe handy. When anomalies are not resolved with a simple maintenance, change the probe (and recalibrate the controller) to see if the problem is alleviated.

SUGGESTED INSTALLATIONS for pH ELECTRODE

The electrode should be installed in such a way that it permanently lies in the solution, whether in a well, tank or on the discharge pipe.

SHORT DISTANCE, INDOOR INSTALLATION

Due to the low currents involved, a very high grade of insulation is required. A dry environment is needed in order to obtain a level of insulation not lower than $10^{12} \Omega$.

This type of connection is very delicate and requires constant attention to maintain proper operating conditions.

The conventional electrodes may be used for indoor applications but the cable length should not exceed 10 m (33').

MEDIUM DISTANCE, INDOOR/OUTDOOR INSTALLATION

When an outdoor installation is required, it is normally necessary to install a transmitter to obtain accurate readings at distances from 10 to 50 m (33-165').

Since the introduction of AmpHel electrodes these distances are no longer a problem. You can now connect your meter directly to an AmpHel electrode, saving the cost of a transmitter.

The standard cable length of the AmpHel electrode is 5 m (16.5'). Additional lengths of regular cable up to 50 m (165'), can be installed without special connectors. It is recommended to use coaxial cables due to their excellent insulation, even though, AmpHel electrodes can operate with both.

AmpHel electrodes have a micro-amplifier in the electrode cap to boost the signal, drastically reducing susceptibility to noise and drift.

For more details about these or other specially made electrodes, consult the Hanna process and water treatment literature, or call the Hanna Office nearest to you.

SUGGESTED INSTALLATIONS for EC/TDS PROBE

As with any other liquid contact measurement, ensure that the probe is installed in such a way that it permanently lies in the solution whether in the tank or the discharge pipe.

HI 3001D FOR IN-LINE INSTALLATION

HI 3001D is suitable for this purpose due to its external 1/2" NPT thread, 6 Bar (87 psi) pressure rating and the short immersion depth of 20 mm (0.8"). It can be installed in 1/2" pipes (with the aid of a "T"). For larger pipe sizes, HI 3001D can be mounted upside down or vertically.

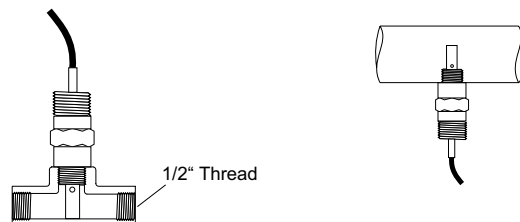

HI 3002 FOR IN-LINE INSTALLATION

The drawing illustrates the ideal installation system since the stream pressure in the pipe forces the air bubbles out automatically. HI 3001D illustrated previously can also be mounted in this fashion. However the longer stem of HI 3002 facilitates an easier escape route for any air bubbles. HI 3002 comes with external 1/2" NPT and thread 60 mm (2.4") immersion level.

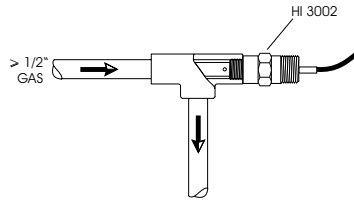

HI 7638 FOR IN-LINE INSTALLATION

HI 7638 comes with stainless steel external 3/8" NPT thread and 60 mm (2.4") immersion level. It can work at temperatures of up to 120 °C and should be used in high temperature/pressure applications such as in boilers (HI 9923).

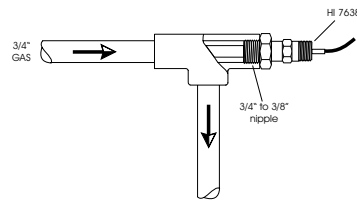

HI 3002 FOR TANK INSTALLATION

Due to its Ultem® and sealed body, HI 3002 can be installed directly in a tank or vat without requiring a probe holder.

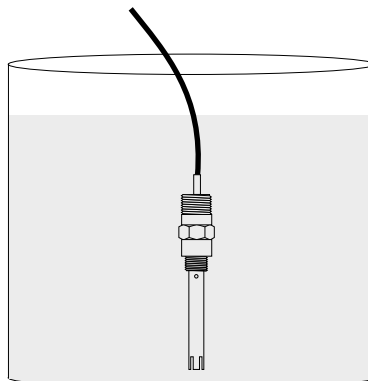

ACCESSORIES

pH ELECTRODES

- HI 1002/3 Double Teflon junction with external threads
- HI 1003/3 Double Teflon junction with matching pin
- HI 2911B/5 Preamplified, double Teflon junction
- HI 1090B/5 Glass double junction with external threads

EC/TDS PROBE

- HI 3001D 1/2" NPT platinum 20 mm (0.8") long, 4-ring probe with temperature sensor and external threads for pipes
- HI 3002 1/2" NPT platinum 60 mm (2.4") 4-ring probe with temperature sensor and external threads for pipes and tanks
- HI 7638 3/8" NPT platinum 60 mm (2.4") 4-ring probe with temperature sensor and stainless steel external threads for high temperature and pressure

Hanna manufactures an extensive range of pH electrodes and EC/TDS probes for process, water treatment and fertilizer applications. Consult the specific handbooks for process instrumentation, or simply call the Hanna Office nearest to you for a complete list.

pH CALIBRATION SOLUTIONS

- HI 7004L pH 4.01 buffer solution, 460 mL
- HI 7007L pH 7.01 buffer solution, 460 mL
- HI 7010L pH 10.01 buffer solution, 460 mL

pH ELECTRODE STORAGE SOLUTION

- HI 70300L Storage solution, 460 mL

ELECTRODE & PROBE CLEANING SOLUTION

- HI 7061L General purpose cleaning solution, 460 mL

EC CALIBRATION SOLUTIONS

- HI 7031L 1.41 mS/cm EC calibration solution, 460 mL
- HI 7039L 5.00 mS/cm EC calibration solution, 460 mL

TDS CALIBRATION SOLUTION

- HI 70442L 1500 ppm (mg/L) TDS calibration solution, 460 mL

OTHER ACCESSORIES

BL PUMPS	Dosing pumps (several models are available with flow rates from 1.5 to 18.3 lph / 0.4 to 4.8 gph)
ChecktempC	Pocket-size thermometer (range -50.0 to 150.0°C)
ChecktempF	Pocket-size thermometer (range -58.0 to 302.0°F)
HI 6050	Submersible pH electrode holder (605 mm/23.8" total length)
HI 6051	Submersible pH electrode holder (1105 mm/43.5" total length)
HI 6054B	Electrode holder for in-line applications
HI 8427	pH Electrode Simulator and high impedance tester with 1 m (3.3') Coaxial Cable ending in a male BNC connector (HI 7858/1)
HI 931001	pH Electrode Simulator with LCD display and 1 m (3.3') Coaxial Cable ending in male BNC connector (HI 7858/1)

WARRANTY



All Hanna controllers are warranted for two years against defects in workmanship and materials when used for their intended purpose and maintained according to instructions.

Damages due to accident, misuse, tampering or lack of prescribed maintenance are not covered. This warranty is limited to free of charge repair or replacement of the meter only, if any malfunctioning is due to manufacturing defects.

If service is required, contact the dealer from whom you purchased the instrument. If under warranty, report the model number, date of purchase, serial number and the nature of the failure. If the repair is not covered by the warranty, you will be notified of the charges incurred. If the instrument is to be returned to Hanna Instruments, first obtain a Returned Goods Authorization Number from the Customer Service department and then send it with shipment costs prepaid. When shipping any instrument, make sure it is properly packaged for complete protection.

To validate your warranty, fill out and return the enclosed warranty card within 14 days from the date of purchase.

CE DECLARATION OF CONFORMITY

										
 DECLARATION OF CONFORMITY										
We Hanna Instruments Srl V.le delle industrie 12 35010 Ronchi di Villafranca (PD) ITALY										
herewith certify that the wall-mounted instrument: HI 9913 HI 9923 HI 9935										
has been tested and found to be in compliance with the following regulations: <table><tr><td>IEC 801-2</td><td>Electrostatic Discharge</td></tr><tr><td>IEC 801-3</td><td>RF Radiated</td></tr><tr><td>IEC 801-4</td><td>Fast Transient</td></tr><tr><td>EN 55022</td><td>Radiated, Class B</td></tr><tr><td>EN 61010-1</td><td>User Safety Requirement</td></tr></table>	IEC 801-2	Electrostatic Discharge	IEC 801-3	RF Radiated	IEC 801-4	Fast Transient	EN 55022	Radiated, Class B	EN 61010-1	User Safety Requirement
IEC 801-2	Electrostatic Discharge									
IEC 801-3	RF Radiated									
IEC 801-4	Fast Transient									
EN 55022	Radiated, Class B									
EN 61010-1	User Safety Requirement									
Date of Issue: 07-06-1999	 D. Volpato - Engineering Manager On behalf of Hanna Instruments S.r.l.									

Recommendations for Users

Before using this product, make sure that it is entirely suitable for the environment in which it is used.

Operation of this instrument in residential areas could cause unacceptable interference to radio and TV equipment.

Any variation introduced by the user to the supplied equipment may degrade the instruments' EMC performance.

Unplug the instrument from power supply before replacing the fuse or making any electrical connections.

All rights are reserved. Reproduction in whole or in part is prohibited without the written consent of the copyright owner, Hanna Instruments Inc., 584 Park East Drive, Woonsocket, Rhode Island, 02895, USA.

Hanna Instruments reserves the right to modify the design, construction and appearance of its products without advance notice.

HANNA LITERATURE

Hanna publishes a wide range of catalogs and handbooks for an equally wide range of applications. The reference literature currently covers areas such as:

- Water Treatment
- Process
- Swimming Pools
- Agriculture
- Food
- Laboratory
- Thermometry

and many others. New reference material is constantly being added to the library.

For these and other catalogs, handbooks and leaflets, contact your dealer or the Hanna Customer Service Center nearest to you. To find the Hanna Office in your vicinity, check our home page at www.hannainst.com.



<http://www.hannainst.com>